

Sizes		EKO L 67 LD 670/400	EKO L 67 LD 670/450
1	A	mm	670
2	F	mm	915 965
3	C	mm	415
4	DN	Ø mm	160
5	B	mm	400 450
6	V	mm	780
7	R	mm	
8	AA	mm	
9	H	mm	
10	J	mm	350 + /100/
11	K	Ø mm	4x125
12	L	Ø mm	125
13	M	mm	
14	N	mm	50

Basic accessories:

Thermodynamical hearth
 Segmental chamotte lining
 Glass classic
 Inox door-handle RP2,RP1,RP1A
 Coated with ecological paint

Optional accessories:

Convection casing (DP)
 Vertical heat-storing panel (AZ)
 Heat accumulation quadrant (APO)
 Lava basket (KL)
 Glass Reflex (SR)
 Glass Modern (SM)
 Cover frame (KR)

Technical parameters			
1	Nominal heat output	kW	7,5
2	Pressure required	Pa	12
3	Average efficiency	%	78,3
4	Average flue gas temperature	°C	245
5	Wood consuption	kg/h	2,3
6	Consumption of combustion air	m ³ /h	23
7	Emission of CO to 13% O2	%	0,1
8	Flue gas mass flow	g/s	8,9
9	Weight	kg	170
10	Required min. cross section for circulating air - INPUT	cm ²	225
11	Required min. cross section for circulating air - OUTPUT	cm ²	375
12	Three-component insulated chimney - active height 4 m	Ø cm	160
13	Character of building construction with fireplace insert	warm air convection	yes
		heat storage without conv	yes

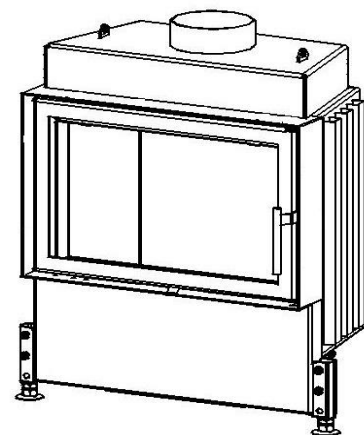

Test Method: ČSN EN 1322/A2:2007, FprEN16510-1, FprEN16510-2-2

Fireplace complies with the requirements: STN EN 13229, DIN +, BlmSchV-Stufe 2, Commission Regulation (EU) č. 2015/1185 Ecodesign requirements

KOBOK reserves the right to change dimensions and parameters described in these sheets. The current edition can be downloaded from www.KOBOK.sk